

THE STANDARD WORLD MAKES THE OFFICIAL STANDARDS OF THE WORLD TO COLLABORATE. THE PURPOSE OF ESTABLISHING THE STANDARD WORLD IS TO ADDRESS THE WORLD WIDE.

"A STANDARD IS SOMETHING THAT IS USED AS A MEASUREMENT-NORM OR MODEL IN COMPARATIVE EVALUATIONS."

In the 19th century, a military flag was used as a measurement-norm or model in comparative evaluations. The flag to the top, take the standard. It was important for the soldiers to trust the standard, then they could raise the flag to the top. The world standard comes from old French; Estrenant, on the eastern consists of a pole stuck in the ground, the soldiers for the ground, then they could raise the flag to the top. It was used as a word to describe a military flag.

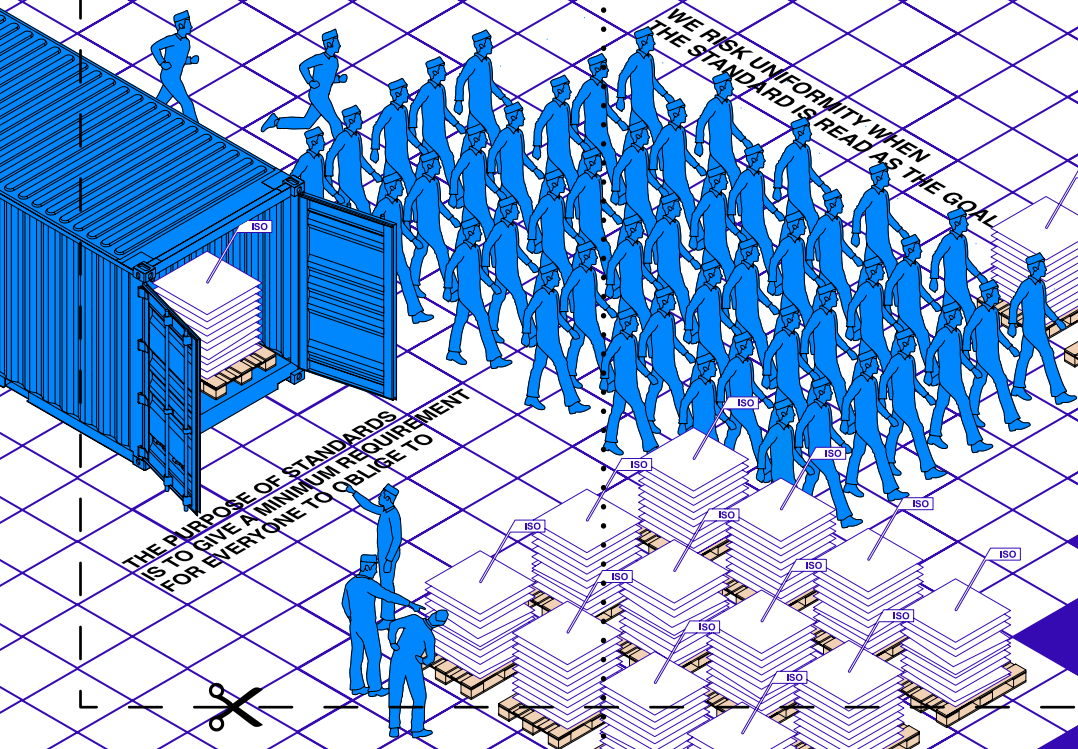

THE PURPOSE OF STANDARDS IS TO GIVE A MINIMUM REQUIREMENT FOR EVERYONE TO OBLIGE TO

WE RISK UNIFORMITY WHEN THE STANDARD IS READ AS THE GOAL

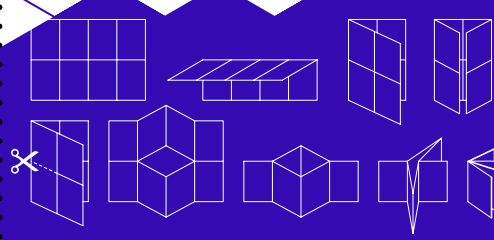
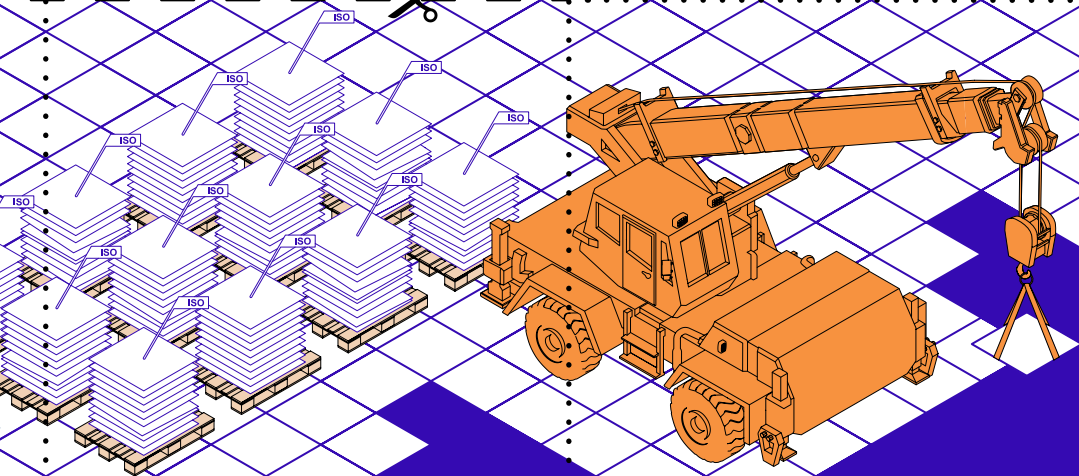

POST STANDARDIZATION THE SHORT VERSION

MASSMINORITY

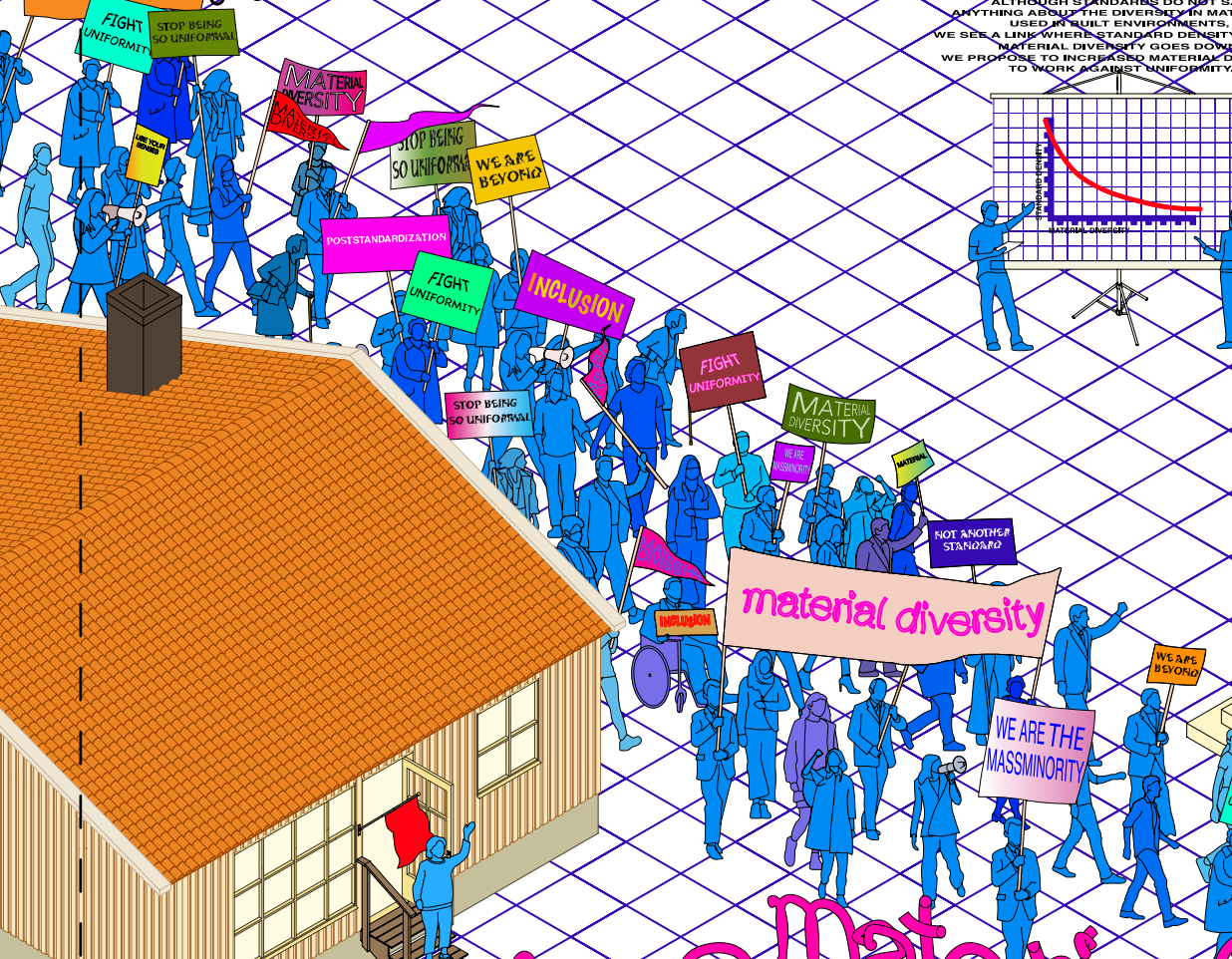

ALTHOUGH STANDARDS DO NOT SAY ANYTHING ABOUT THE DIVERSITY IN MATERIALS USED IN BUILT ENVIRONMENTS, WE SEE A LINK WHERE STANDARD DENSITY GOES UP, MATERIAL DIVERSITY GOES DOWN. WE PROPOSE TO INCREASED MATERIAL DIVERSITY TO WORK AGAINST UNIFORMITY.

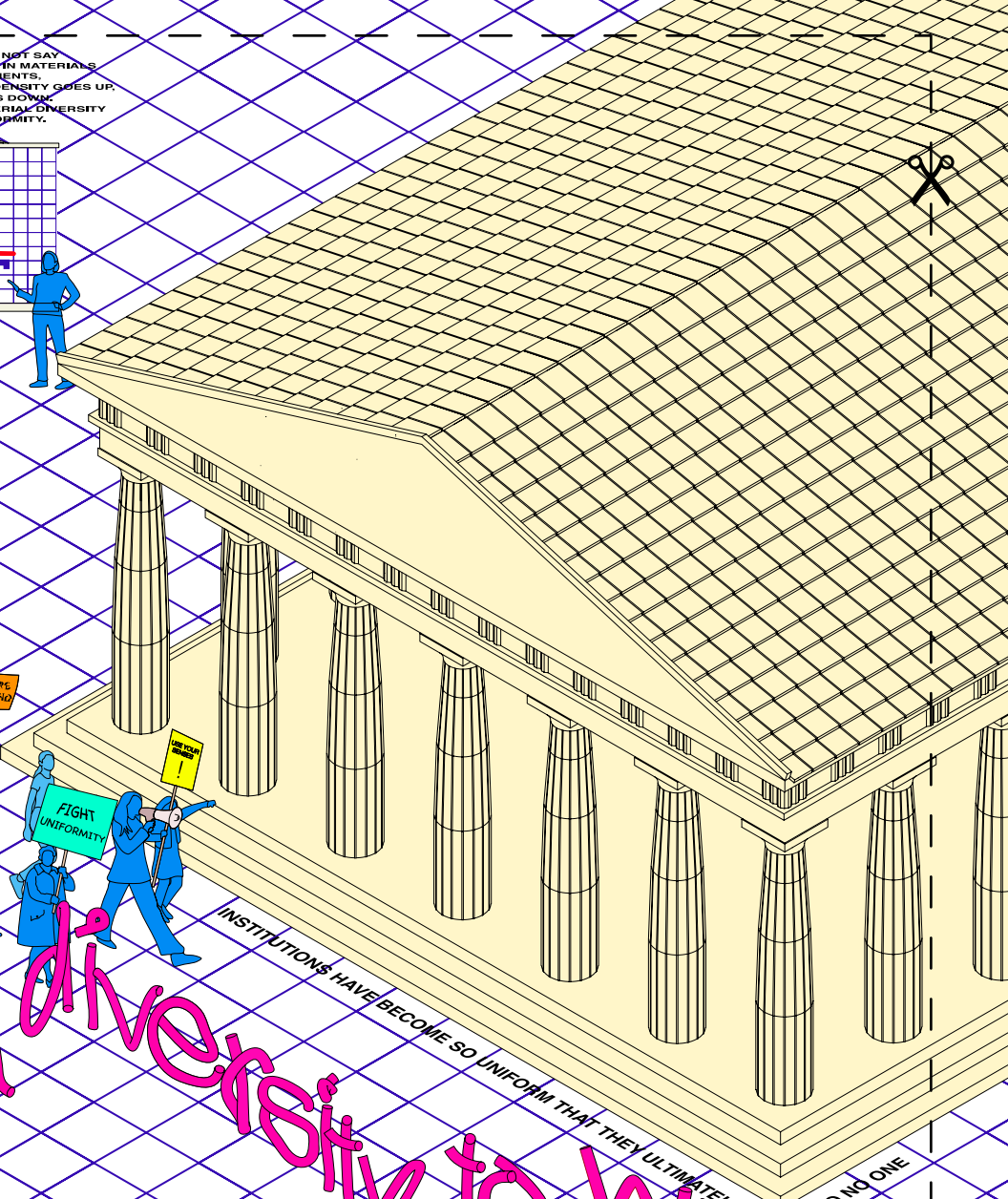
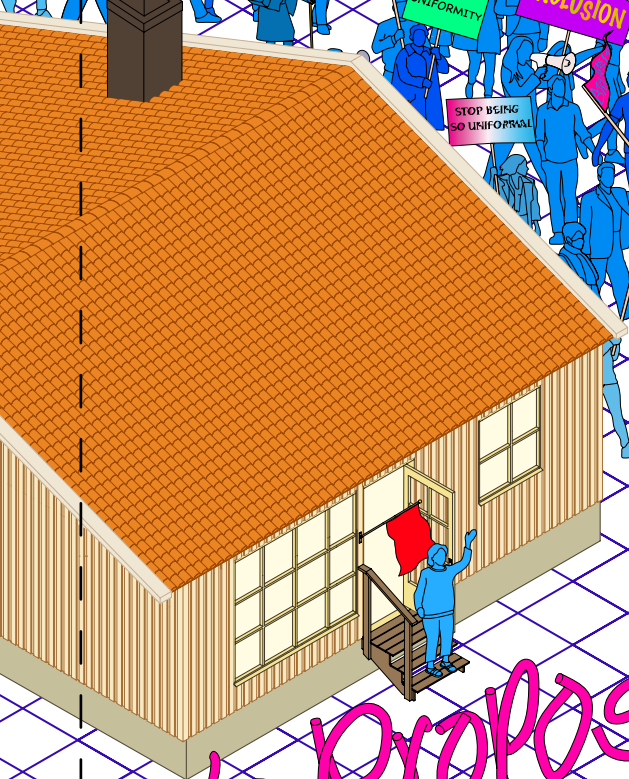
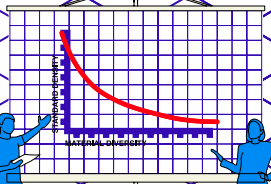

We propose material diversity to work against uniformity.

FOR THE LONG VERSION GO TO POSTSTANDARDIZATION.INFO